

## RP187 Series

## High Performance IEC Inlet Dual Stage Power Line Filter

### RP187 DUAL STAGE TO 20A IEC INLET

ROHS COMPLIANT



### SPECIFICATIONS

Operating Freq.	: 50/60Hz
Max. Operating Voltage	: 250V +10%
Ambient Temperature	: -25 to 40C
Climatic Category	: 25/100/21
Hipot Rating (L-G)	: 2121VDC
Plastic Mtg Force	: 18 LBS
Terminals (-T)	: QD: 0.25 Tabs
Safety Approvals	: CSA, UR, EN60939

### LEAKAGE CURRENT

Y-cap, nF	mA, 120V/60Hz	mA, 250V/60Hz
0	0	0
.47	0.04	0.08
1	0.09	0.18
2.2	0.2	0.4
4.7	0.4	0.8

### PART NUMBER/ ORDERING

RP187	-X (Amps)	-Y (Ycap, nF)	-T	Weight LBS (KG) Typ.
	1	0	QD	0.4 (0.2)
	3	.47		0.4 (0.2)
	6	1		0.4 (0.2)
	10	2.2		0.4 (0.2)
	20	4.7		0.45 (0.21)

**Note:** Use any combination of -Y with any -X (Amps) rating  
e.g. RP187-1-.47-QD (1Amps with .47nF Ycap)

### SCHEMATIC

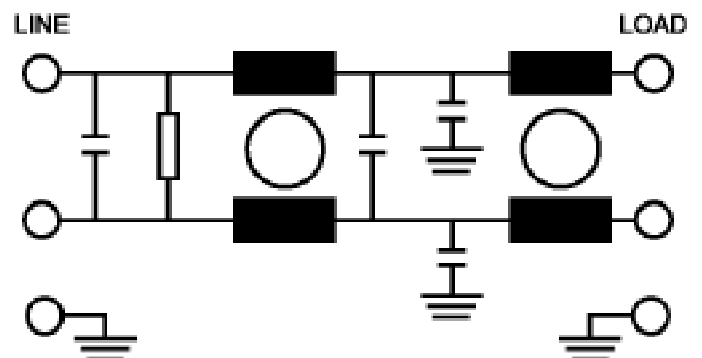

Reference purposes only.  
Specifications are subject to change.  
Consult factory to verify specifications.

## RP187

### Typical Insertion Loss, dB (50/50ohm) Mechanical Dimensions

1 Amp					
FREQ (MHz)	.15	.5	1.0	10	30
CM(dB)	52	60	65	65	50
DM(dB)	28	45	65	65	55

3 Amp					
FREQ (MHz)	.15	.5	1.0	10	30
CM(dB)	45	60	65	65	50
DM(dB)	28	45	65	65	60

6 Amp					
FREQ (MHz)	.15	.5	1.0	10	30
CM(dB)	30	50	60	60	60
DM(dB)	26	40	60	60	55

10 Amp					
FREQ (MHz)	.15	.5	1.0	10	30
CM(dB)	28	40	50	55	55
DM(dB)	26	38	55	60	60

20 Amp					
FREQ (MHz)	.15	.5	1.0	10	30
CM(dB)	18	35	45	50	58
DM(dB)	16	35	55	55	70

1/3/6/10 Amp

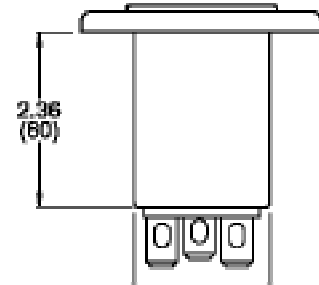
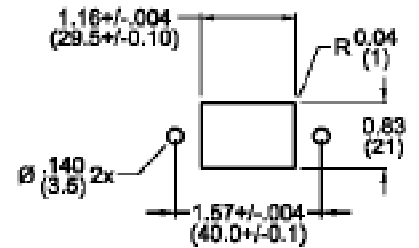
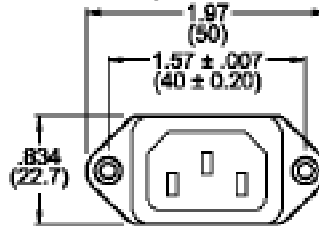

20 Amp

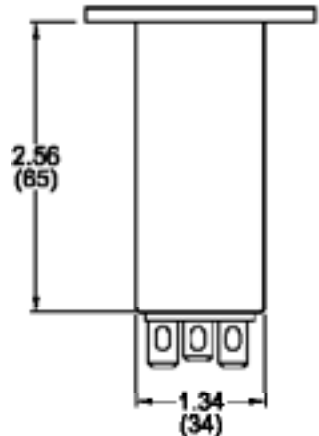
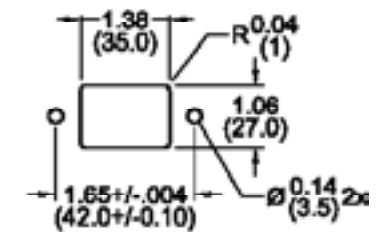
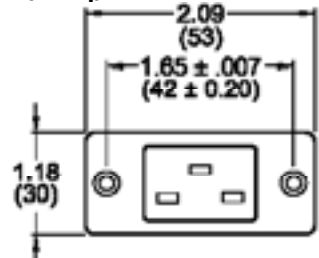

TYPICAL TOLERANCE: +/-0.02 (0.50)

Reference purposes only.  
Specifications are subject to change.  
Consult factory to verify specifications.

[www.radiuspower.com](http://www.radiuspower.com)  
[www.astrodyne.com](http://www.astrodyne.com)

Email: [Emifiltercs@astrodyne.com](mailto:Emifiltercs@astrodyne.com)