

## RP300 Series

## 3-Phase Delta Single Stage Power Line Filter

### RP300 3PHASE DELTA TO 500A

ROHS COMPLIANT



### SPECIFICATIONS

Operating Freq.	: 50/60Hz
Usable Freq.	: DC - 400Hz
Max. Operating Voltage	: 480V +10%
Ambient Temperature	: -25 to 50C
Climatic Category	: 25/100/21
Hipot Rating (L-G)	: 3500VDC
Terminals (-T)	: S: 25/50/55A (M5) 65/100A (M6) 150/200A (M10) 300A (M12) 500A (Dual M12)
Safety Approvals	: cURus, EN60939

### LEAKAGE CURRENT

Y-cap, nF	mA, 480V/60Hz
0	0
10	0.1
100	1
1000	10
2000	20

### PART NUMBER/ ORDERING

RP300	-X (Amps)	-Y (Ycap, nF)	-T	Weight LBS (KG) Typ.
	25	0	S	4.6 (2.1)
	50	10		5.8 (2.6)
	55	100		5.8 (2.6)
	65	1000		6.5 (3.0)
	100	2000		11.0 (5.0)
	150			14.4 (6.7)
	200			17.8 (8.1)
	300			19.7 (8.9)
	500			24.0 (10.9)

**Note:** Use any combination of -Y with any -X (Amps) rating  
e.g. RP300-500-2000-S (500 Amps with 2000nF Ycap)

### SCHEMATIC

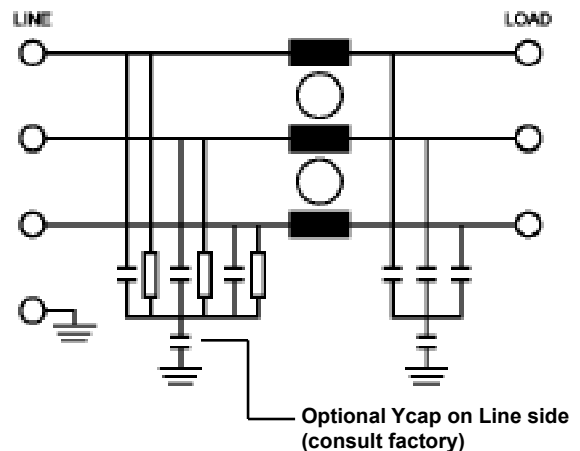

Reference purposes only.  
Specifications are subject to change.  
Consult factory to verify specifications.

## RP300

### Typical Insertion Loss, dB (50/50ohm) Mechanical Drawings

25 Amp					
FREQ (MHz)	.15	.5	1	10	30
CM (dB)	75	75	75	60	50
DM (dB)	60	75	75	68	50

50 Amp					
FREQ (MHz)	.15	.5	1	10	30
CM (dB)	65	75	70	55	50
DM (dB)	50	75	75	75	65

55/65 Amp					
FREQ (MHz)	.15	.5	1	10	30
CM (dB)	55	70	70	65	45
DM (dB)	65	75	75	75	50

100 Amp					
FREQ (MHz)	.15	.5	1	10	30
CM (dB)	70	75	75	60	50
DM (dB)	50	75	75	60	55

25/50 Amp

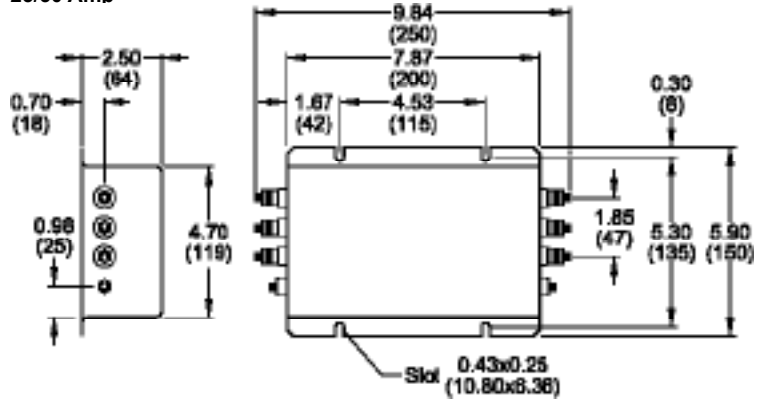

50Amp identical to 25A, except height is 3.20 (81) and bottom to center of stud is 1.25 (32)

55/65 Amp

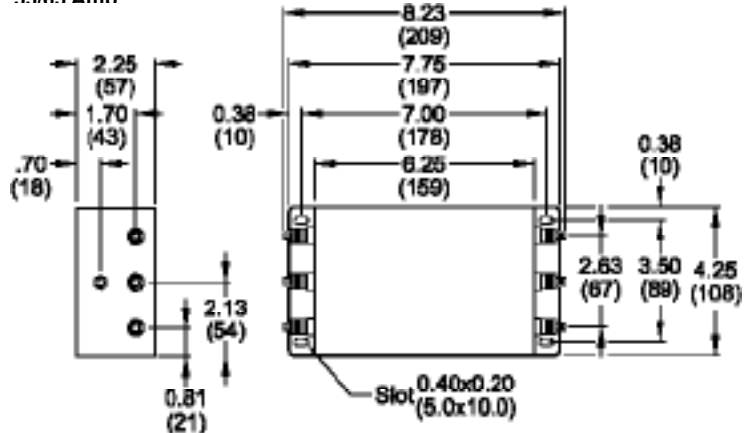

100 Amp

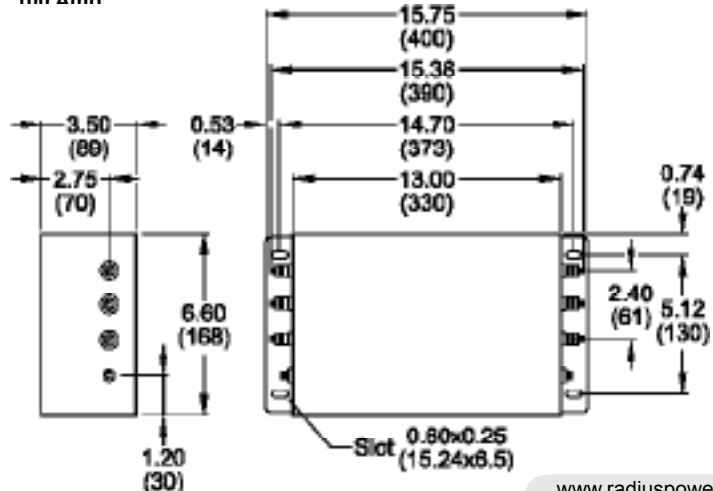

TYPICAL TOLERANCE: +/-0.02 (0.50)

[www.radiuspower.com](http://www.radiuspower.com)  
[www.astrodyne.com](http://www.astrodyne.com)

Email: [Emifiltercs@astrodyne.com](mailto:Emifiltercs@astrodyne.com)

Reference purposes only.  
 Specifications are subject to change.  
 Consult factory to verify specifications.

## RP300

Typical Insertion Loss, dB (50/50ohm)

Mechanical Dimensions

150 Amp					
FREQ (MHz)	.15	.5	1	10	30
CM (dB)	50	70	60	48	40
DM (dB)	50	75	70	45	45

200 Amp					
FREQ (MHz)	.15	.5	1	10	30
CM (dB)	48	70	60	48	40
DM (dB)	50	75	70	45	45

300/500 Amp					
FREQ (MHz)	.15	.5	1	10	30
CM (dB)	60	50	50	45	40
DM (dB)	50	45	45	40	30

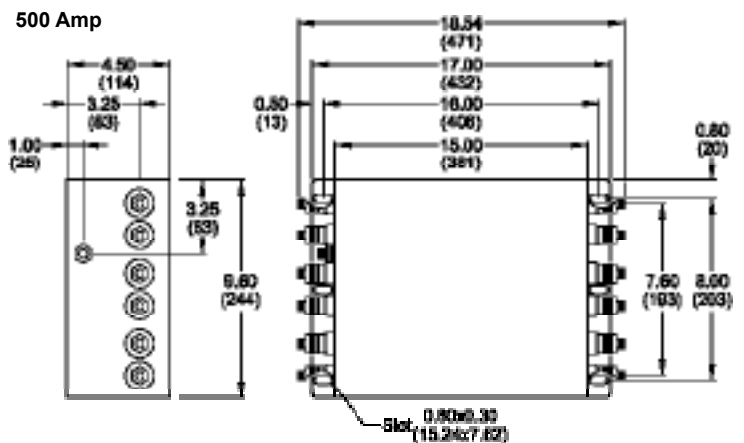
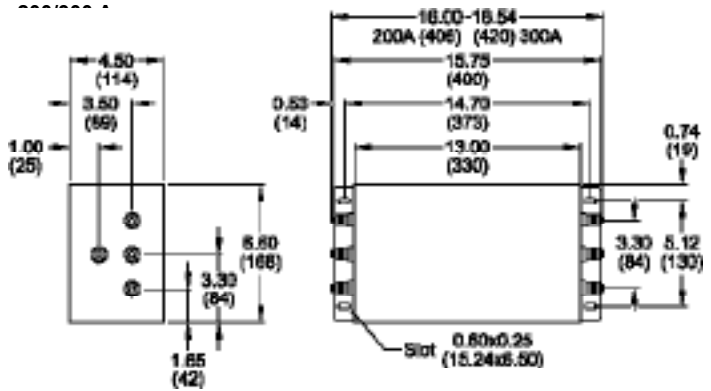
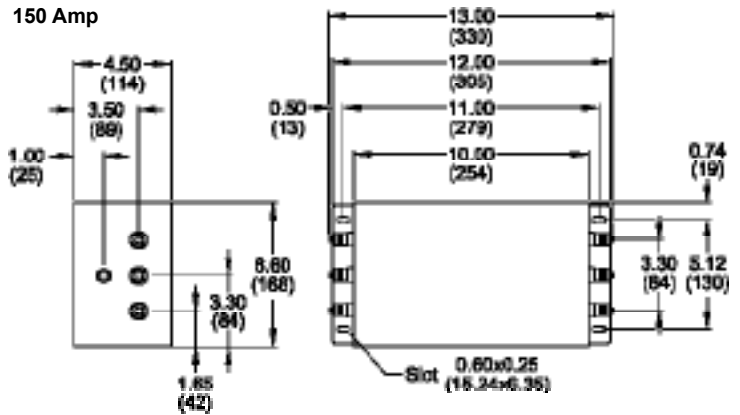

TYPICAL TOLERANCE: +/-0.02 (0.50)

Reference purposes only.  
Specifications are subject to change.  
Consult factory to verify specifications.