

DSC1000-3

High Performance Dual Stage Power Line Filter

DSC1000-3 16A CHASSIS MOUNT FILTER

ROHS COMPLIANT

SPECIFICATIONS

Operating Freq.	: 50/60Hz
Usable Freq.	: DC - 400Hz
Max. Operating Voltage	: 300V +10%
Rated Current	: 16A
Ambient Temperature	: -25 to 40C
Climatic Category	: 25/100/21
Hipot Rating (L-G)	: 2700VDC
Terminals (-T)	: QD: 0.25 Tabs
Safety Approvals	: cURus, EN60939
Typ. Weight, LBS (KG)	: 0.8 (0.4)



SCHEMATIC

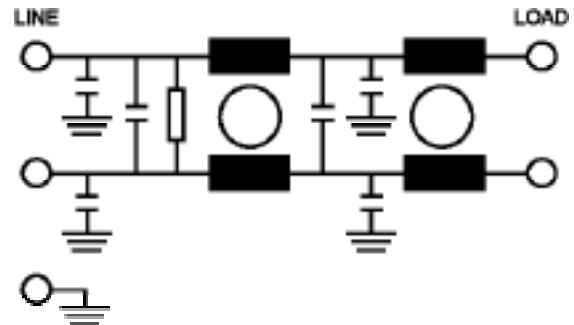

TYPICAL INSERTION LOSS, dB (50/50ohm)

FREQ(MHz)	.15	.5	1.0	10	30
CM(dB)	46	64	70	70	60
DM(dB)	36	60	65	70	70

PART NUMBER/ ORDERING

DSC1000-3	-Y (Ycap) (Center) (nF)	-Z (Ycap) (Line) (nF)	-T	LK, mA	
				120V 60Hz	250V 60Hz
	0	0	QD	0	0
	.47	.47		0.08	0.16
	1	1		0.18	0.35
	2.2	2.2		0.4	0.8
	4.7	4.7		0.8	1.6
	10	10		1.8	3.5

Note: Use any combination of -Y and -Z

Reference purposes only.
Specifications are subject to change.
Consult factory to verify specifications.

MECHANICAL

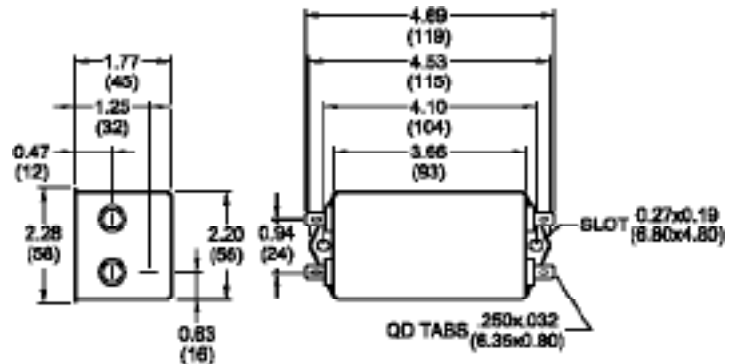

TYPICAL TOLERANCE: +/-0.02 (0.50)

www.radiuspower.com
www.astrodyne.com

Email: Emifiltercs@astrodyne.com